

Owner's Guide 0300127-04 Rev. F

SLC 500™ ISOLATED ANALOG INPUT MODULES

Catalog Numbers

1746sc-INI4i

1746sc-INI4vi



SC SPECTRUM
C O N T R O L S

Important Notes

1. Read all the information in this guide before installing the product.
2. The information in this owner's guide applies to hardware and software version 1.0 or later.
3. This guide assumes that the reader has a full working knowledge of the relevant processor.

Notice

The products and services described in this owner's guide are useful in a wide variety of applications. Therefore, the user and others responsible for applying the products and services described herein are responsible for determining their acceptability for each application. While efforts have been made to provide accurate information within this owner's guide, Spectrum Controls assumes no responsibility for the accuracy, completeness, or usefulness of the information herein.

Under no circumstances will Spectrum Controls be responsible or liable for any damages or losses, including indirect or consequential damages or losses, arising out of either the use of any information within this owner's guide or the use of any product or service referenced herein.

No patent liability is assumed by Spectrum Controls with respect to the use of any of the information, products, circuits, programming, or services referenced herein.

The information in this owner's guide is subject to change without notice.

Limited Warranty

Spectrum Controls warrants that its products are free from defects in material and workmanship under normal use and service, as described in Spectrum Controls literature covering this product, for a period of 1 year. The obligations of Spectrum Controls under this warranty are limited to replacing or repairing, at its option, at its factory or facility, any product which shall, in the applicable period after shipment, be returned to the Spectrum Controls facility, transportation charges prepaid, and which after examination is determined, to the satisfaction of Spectrum Controls, to be thus defective.

This warranty shall not apply to any such equipment which shall have been repaired or altered except by Spectrum Controls or which shall have been subject to misuse, neglect, or accident. In no case shall the liability of Spectrum Controls exceed the purchase price. The aforementioned provisions do not extend the original warranty period of any product which has either been repaired or replaced by Spectrum Controls.

Table Of Contents

	Preface	
	Who Should Use This Guide	3
	What This Guide Covers	3
	Related Allen-Bradley Documents	3
	Terms & Abbreviations You Should Know	4
Overview & Specifications	Chapter 1	
	General Features And Benefits	7
	Detailed Specifications	8
Installing And Wiring Your Module	Chapter 2	
	Avoiding Electrostatic Damage	12
	Determining Power Requirements	12
	Selecting A Rack Slot	13
	Inserting Your Module Into The Rack	13
	Wiring Your Module	14
Things To Consider Before Using Your Module	Chapter 3	
	How The Processor Communicates With Your Module	19
	The Difference Between Channel Update Time & Step Response Time ...	21
	Selecting An Input Filter Frequency	22
	Auto-Calibration Time	25
	Channel Enable And Disable Times	25
	Your Module's Response To Slot Disabling	26
Using Your Input Module	Chapter 4	
	Entering Your Module's ID Code	27
	Configuring Each Input Channel	28
	Setting The User-Defined Scale Limits (optional)	33
	Monitoring Each Input Channel	35
	Checking Each Input Channel's Configuration And Status	35
Programming Examples	Chapter 5	
	PID Control	39
	User-Defined Scaling	41
Testing Your Module	Chapter 6	
	Inspecting Your Module	43
	Disconnecting Prime Movers	44
	Powering Up	44
	Interpreting The LED Indicators	45
	Interpreting I/O Error Codes	45
	Troubleshooting	46

Maintaining Your Module And Ensuring Safety

Chapter 7

Preventive Maintenance	47
Safety Considerations	47

Verifying Calibration

Appendix A

Recommended Schedule	49
Verifying Current Inputs	49
Verifying Voltage Inputs (-INI4vi only)	50
Service	50

Index

.....	51
-------	-----------

Figures

Figure 1. Wiring diagrams (showing differential inputs)	16
Figure 2. Wiring schematic for 2-, 3-, and 4-wire analog inputs	18
Figure 3. Wiring schematic for single-ended analog inputs	18
Figure 4. Image table for your isolated analog input module	20
Figure 5. Channel update time and full-scale step response time	21
Figure 6. Signal attenuation with 50 Hz input filter	23
Figure 7. Signal attenuation with 60 Hz input filter	24
Figure 8. Signal attenuation with 250 Hz input filter	24
Figure 9. Signal attenuation with 500 Hz input filter	25
Figure 10. Graph of signal value vs data value	34
Figure 11. PID control example	39
Figure 12. Programming for PID control example	40
Figure 13. Data table for PID control example	40
Figure 14. User-defined scaling example	41
Figure 15. Programming for user-defined scaling example	41
Figure 16. Data table for user-defined scaling example	41
Figure 17. LED block	45
Figure 18. Problem resolution flowchart	46

Tables

Table 1. Related Allen-Bradley documentation	4
Table 2. Electrical specifications—module	8
Table 3. Electrical specifications—inputs	9
Table 4. Physical specifications	10
Table 5. Environmental specifications	10
Table 6. Backplane current consumed	12
Table 7. Input module terminal block connections	17
Table 8. Cut-off frequency, step response time, & effective resolution	22
Table 9. Channel update time	23
Table 10. Auto-calibration time per channel	25
Table 11. Channel enable and disable times	25
Table 12. Module ID codes	27
Table 13. Input channel configuration word (O:e.0 through O:e.3)	29
Table 14. Data format definitions	31
Table 15. Input channel status word (I:e.4 through I:e.7)	36
Table 16. LED definition	45

Preface

Read this preface to familiarize yourself with the rest of the owner's guide. This preface covers:

- who should use this guide
- what this guide provides
- related Allen-Bradley documents
- terms & abbreviations you should know

Who Should Use This Guide

Use this guide if you design, install, program, or maintain a control system that uses Allen-Bradley Small Logic Controllers.

You should have a basic understanding of SLC 500 products. You should also understand electronic process control and the ladder program instructions required to generate the electronic signals that control your application. If you do not, contact your local Allen-Bradley representative for the proper training before using these products.

What This Guide Covers

This guide covers the 1746sc-INI4i and 1746sc-INI4vi isolated analog input modules. It contains the information you need to install, wire, use, and maintain these modules. It also provides diagnostic and troubleshooting help should the need arise.

Related Allen-Bradley Documents

Table 1 lists several Allen-Bradley documents that may help you as you use these products.

Table 1. Related Allen-Bradley documentation

Allen-Bradley Doc. No.	Title
1747-2.30	SLC 500 System Overview
SGL-1.1	Application Considerations for Solid State Controls
1770-4.1	Allen-Bradley Programmable Controller Grounding and Wiring Guidelines
1747-6.2	Installation & Operation Manual for Modular Hardware Style Programmable Controllers
1747-NI001	Installation & Operation Manual for Fixed Hardware Style Programmable Controllers
1747-6.4	Allen-Bradley Advanced Programming Software (APS) User Manual
1747-6.11	Allen-Bradley Advanced Programming Software (APS) Reference Manual
1747-6.3	Getting Started Guide for Advanced Programming Software (APS)
ABT-1747-TSG001	SLC 500 Software Programmers's Quick Reference Guide
1747-NP002	Allen-Bradley HHT (Hand-Held Terminal) User Manual
1747-NM009	Getting Started Guide for HHT (Hand-Held Terminal)
SD499	Allen-Bradley Publication Index
AG-7.1	Allen-Bradley Industrial Automation Glossary

To obtain a copy of any of the Allen-Bradley documents listed, contact your local Allen-Bradley office or distributor.

Terms & Abbreviations You Should Know

You should understand the following terms and abbreviations before using this guide. For the definitions of terms not listed here, refer to *Allen-Bradley's Industrial Automation Glossary*, Publication AG-7.1

A/D – Refers to analog-to-digital conversion. The conversion produces a digital value whose magnitude is proportional to the instantaneous magnitude of an analog input signal.

Attenuation – The reduction in magnitude of a signal as it passes through a system. The opposite of gain.

Channel – Refers to one of the sets of signal interfaces available on a module's terminal block.

Channel update time – For analog inputs, the time required for a channel to sample and convert signals and make the resulting data available to the processor. For analog outputs, the time required for the

channel to convert the data received from the processor to analog output signals at the terminals.

Chassis – See rack.

Common mode rejection – The maximum level to which a common mode input voltage appears in the numerical value read by the processor, expressed in dB.

Common mode rejection ratio (CMRR) – The ratio of a device's differential voltage gain to common mode voltage gain. Expressed in dB, CMRR is a comparative measure of a device's ability to reject interference caused by a voltage common to its terminal relative to ground.

Common mode voltage – The voltage difference between the negative terminal and analog common during normal differential operation.

Common mode voltage range – The largest voltage difference allowed between either the positive or negative terminal and analog common during normal differential operation.

Configuration word – Contains the channel configuration information needed by the module to configure and operate each channel. Information is written to the configuration word through the logic supplied in your ladder program.

Cut-off frequency – The frequency at which the input signal is attenuated 3 dB by the digital filter. Frequency components of the input signal that are below the cut-off frequency are passed with under 3 dB of attenuation for low-pass filters.

dB (decibel) – A logarithmic measure of the ratio of two signal levels.

Data scaling - The data format that you select to define the logical increments of the channel data word.

Data word – A 16-bit integer that represents the value of the analog input channel. The channel data word is valid only when the channel is enabled and there are no channel errors.

Differential operation – The difference in voltage between a channel's positive and negative terminals.

Effective resolution – The number of bits in the channel data word that do not vary due to noise.

Filter frequency – The user-selectable first-notch frequency for the A/D converter's digital filter. The digital filter provides high noise rejection at the selected frequency.

Full-scale error (gain error) – The difference in slope between the actual and ideal analog transfer functions.

Full-scale range (FSR) – The difference between the maximum and minimum specified analog values.

Gain drift – The change in full-scale transition voltage measured over the operating temperature range of the module.

LSB (least significant bit) – The bit that represents the smallest value within a string of bits. The “weight” of this value is defined as the full-scale range divided by the resolution.

Maximum differential voltage – The largest voltage difference allowed between the negative terminal and positive terminal during normal differential operation.

Module ID code – A unique number associated with each 1746 I/O module. The code defines for the processor the type of I/O or specialty module residing in a specific slot in the 1746 chassis.

Module update time – See channel update time.

Normal mode rejection (differential mode rejection) – A logarithmic measure, in dB, of a device’s ability to reject noise signals between or among circuit signal conductors, but not between the equipment grounding conductor or signal reference structure and the signal conductors.

Overall accuracy – The worst-case deviation of the signal over the full range, expressed in percent of full scale.

Rack – A hardware assembly that houses devices such as I/O modules, adapter modules, processor modules, and power supplies.

Repeatability – The closeness of agreement among repeated measurements of the same variable under the same conditions.

Resolution – The smallest detectable change in a measurement, typically expressed in engineering units (e.g. 0.15 °C) or as a number of bits. For example, a 12-bit system has 4096 possible output states. It can therefore measure 1 part in 4096. See also effective resolution.

Sampling time – The time required by the A/D converter to sample an input channel.

Status word – Contains status information about the channel’s current configuration and operational state. You can use this information in your ladder program to determine whether the channel data word is valid.

Step response time – The time required for the A/D signal to reach 95% of its expected, final value, given a full-scale step change in the input signal.

Useful resolution – See effective resolution.

Overview And Specifications

The 1746sc-INI4i monitors up to 4 isolated analog current inputs, while the 1746sc-INI4vi monitors up to 4 isolated analog current *or* voltage inputs (selectable by channel). In both modules, you can select different input ranges (for example, 4–20 mA or 1–5 Vdc) independently, by channel, for optimal use of rack space.

Read this chapter to familiarize yourself further with your isolated analog module. This chapter covers:

- general features and benefits
- detailed specifications

General Features And Benefits

Increased Accuracy and Reliability

Both modules provide 750 Vdc channel-to-channel isolation, which means no electrical crosstalk between channels (resulting in less noise and a high *effective* resolution). They also provide 750 Vdc field wiring-to-backplane isolation to protect your processor and other rack components. And for state-of-the-art precision, they offer 16-bits of resolution.

For added reliability, both modules perform a battery of diagnostic tests at startup and can alert you to open input circuits through status bits and LEDs. The open-circuit response state is selectable. Onboard over-voltage and over-current protection also help prevent damage to the module due to wiring errors.

Reduced System Costs

Because channel-to-channel isolation is built into these modules, they eliminate the need for expensive, external analog isolation blocks and the time and space required to install them. Both modules provide a single-slot solution for applications requiring up to 4, mixed, analog inputs. They also feature auto-calibration, so you never have to perform this time-consuming task.

State-of-the-Art Performance

These modules incorporate proprietary Allen-Bradley technology, so they operate and perform like the latest high-performance Allen-Bradley products for full compatibility. Four selectable filter frequencies are provided for signal/noise optimization. For even greater convenience, they are fully configured through software (no DIP switches), can alert the processor to a variety of errors through status bits, and can scale input signals to user-defined ranges without any ladder programming.

Detailed Specifications

Table 2. Electrical specifications—module

Backplane Current Consumption (typical)	
1746sc-INI4i	440 mA @ 5 Vdc 0 mA @ 24 Vdc
1746sc-INI4vi	550 mA @ 5 Vdc 0 mA @ 24 Vdc
Backplane Power Consumption (typical)	2.75 W
Number Of Channels	4 (differential, individually isolated)
I/O Chassis Location	Any 1746 I/O module slot except slot 0
A/D Conversion Method	Sigma-Delta
Input Filtering	Programmable notch filters
Normal Mode Rejection (between + and - inputs)	98 dB @ 50 Hz 98 dB @ 60 Hz
Common Mode Rejection (between inputs and chassis ground)	99 dB @ 1 kHz, 25 °C
Calibration	Factory calibrated Autocalibrated every 10 sec (when enabled)
Opto-Electrical Isolation (10 sec)	750 Vdc channel-to-channel 750 Vdc field wiring-to-backplane
Module ID Code	
1746sc-INI4i	3522
1746sc-INI4vi	3520
Thermal Dissipation	3.25 W maximum

Table 3. Electrical specifications—inputs

Input Current Ranges (selectable for each channel)	4 to 20 mA 0 to 20 mA
Input Voltage Ranges—INI4vi only (selectable for each channel)	-10 to +10 Vdc 0 to 10 Vdc 0 to 5 Vdc 1 to 5 Vdc
SLC Communication Formats (selectable for each channel)	Scaled engineering units Scaled for PID Proportional counts 1746-NI4 format User-defined scale A User-defined scale B
Input Impedance Current Inputs Voltage Inputs—INI4vi only	Less than 250 Ω Greater than 220 k Ω
Input Overcurrent Protection	70 mA non-continuous 33 mA continuous
Input Overvoltage Protection—INI4vi only	50 Vdc continuous
Input Filter 3 dB Cut-Off Frequencies (selectable for each channel)	13.1 Hz for 50 Hz filter 15.7 Hz for 60 Hz filter 65.5 Hz for 250 Hz filter 131 Hz for 500 Hz filter
Input Step Response Time	80 ms for 50 Hz filter 66.7 ms for 60 Hz filter 16 ms for 250 Hz filter 8 ms for 500 Hz filter
Channel Update Time (minimum) Current Inputs Voltage Inputs—INI4vi only	14 ms with 500 Hz filters and all channels enabled 18 ms with 500 Hz filters and all channels enabled
Input Resolution (maximum) Current Inputs Voltage Inputs—INI4vi only	16-bit 312.8 nA/count 312.8 μ V/count
Overall Accuracy Current Inputs Voltage Inputs—INI4vi only	0.15% of full scale @ 25 °C 0.25% of full scale @ 60 °C 0.10% of full scale @ 25 °C 0.25% of full scale @ 60 °C
Overall Drift Current Inputs Voltage Inputs—INI4vi only	Offset: \pm 539 nA/°C Gain: \pm 50.5 ppm/°C Offset: \pm 352 μ V/°C Gain: 34.8 ppm/°C

Table 4. Physical specifications

LED Indicators	Four green channel status indicators, one for each channel One green module status indicator
Recommended Cable	Belden 8761 (shielded, twisted-pair) or equivalent
Wire Size (maximum)	One 12–24 AWG wire per terminal
Terminal Block	Removable (supplied)

Table 5. Environmental specifications

Operating Temperature	0 to 60 °C (32 to 140 °F)
Storage Temperature	-40 to 85 °C (-40 to 185 °F)
Relative Humidity	5 to 95% non-condensing
Certifications	UL/CUL and CE
Hazardous Environment Classifications	Class I Division 2

Installing And Wiring Your Module

Read this chapter to install and wire your module. This chapter covers:

- avoiding electrostatic damage
- determining power requirements
- selecting a rack slot
- inserting your module into the rack
- wiring your module

Note that although your module has a jumper on its printed circuit board, this jumper is for the manufacturer's use only, so do not alter its position. Also, your module was calibrated by the manufacturer, so you don't need to perform this task. You may, however, want to verify the calibration periodically using the procedures provided in Appendix A.

The following documents contain information that may help you as you install and wire your module:

- NFPA 79, *Electrical Standard for Industrial Machinery*, published by the National Fire Protection Association of Boston, MA
- *National Electrical Code*, published by the National Fire Protection Association of Boston, MA
- IEEE Standard 518-1977, *Guide for the Installation of Electrical Equipment to Minimize Electrical Noise Inputs to Controllers from External Sources*
- IEEE Standard 142-1982, *Recommended Practices for Grounding of Industrial and Commercial Power Systems*
- *Noise Reduction Techniques in Electronic Systems*, by Henry W. Ott; published by Wiley-Interscience of New York in 1976

Avoiding Electrostatic Damage

Guard against electrostatic damage by observing the following precautions:



CAUTION

ELECTROSTATICALLY SENSITIVE COMPONENTS

- Before handling the module, touch a grounded object to rid yourself of electrostatic charge.
- When handling the module, wear an approved wrist strap grounding device.
- Handle the module from the front, away from the backplane connector. Do not touch backplane connector pins.
- Keep the module in its static-shield container when not in use or during shipment.

Failure to observe these precautions can degrade the module's performance or cause permanent damage.

Determining Power Requirements

The backplane of the SLC 500 system can provide both 5 Vdc and 24 Vdc power. The following table shows the current consumed by your module when using these power sources:

Table 6. Backplane current consumed

Catalog Number	5 Vdc	24 Vdc
1746sc-INI4i	440 mA typical	0 mA
1746sc-INI4vi	550 mA typical	0 mA

Use this table to calculate the total load on the system power supply. For more information, see the system *Installation and Operation Manual*.

Important — Your module does not supply power for input devices. You must supply the appropriate power.

Selecting A Rack Slot

Two factors determine where you should install your module in the rack: ambient temperature and electrical noise. When selecting a slot for your module, try to position your module:

- in a rack close to the bottom of the enclosure (since hot air rises)
- away from modules that generate significant heat, such as 32-point input/output modules
- in a slot away from ac or high-voltage dc modules, hard contact switches, relays, and ac motor drives
- away from the rack power supply (if using a modular system)

Remember that in a modular system, the processor always occupies the first slot of the first rack.

Inserting Your Module Into The Rack



CAUTION

POSSIBLE EQUIPMENT OPERATION

Before installing or removing your module, always disconnect power from the SLC 500 system and from any other source to the module (in other words, don't "hot swap" your module), and disconnect any devices wired to the module.

Failure to observe this precaution can cause unintended equipment operation and damage.

When inserting your module into the rack, you do not need to remove the supplied 16-position terminal block from the module. If, however, you do remove the terminal block, apply the supplied write-on label to the terminal block, and use the write-on label to identify your module's location.

To remove the terminal block, unscrew the two retaining screws at the top and bottom of the terminal block, and using needle-nose pliers, carefully pry the terminal block loose.

To insert your module into the rack, follow these steps:

1. Align the circuit board of your module with the card guides at the top and bottom of the chassis.

2. Slide your module into the chassis until both top and bottom retaining clips are secure. Apply firm even pressure on your module to attach it to its backplane connector. Never force your module into the slot.

Cover all unused slots with the Card Slot Filler, Allen-Bradley part number 1746-N2.

To remove your module, press the retaining clips at the top and bottom of your module and slide it out.

Wiring Your Module

To wire the terminal block, you need:

- a small, flat-blade screwdriver
- Belden 8761 (shielded, twisted pair) cable or equivalent

CAUTION

POSSIBLE EQUIPMENT OPERATION



Before wiring your module, always disconnect power from the SLC 500 system and from any other source to the module.

Failure to observe this precaution can cause unintended equipment operation and damage.

Before wiring the terminal block, take some time to plan your system:

- Ensure that the SLC 500 system is installed in a NEMA-rated enclosure and that the SLC 500 system is properly grounded.
- Route the field wiring away from any other wiring and as far as possible from sources of electrical noise, such as motors, transformers, contactors, and ac devices. As a general rule, allow at least 6 in. (about 15.2 cm) of separation for every 120 V of power.
- Routing the field wiring in grounded conduit can reduce electrical noise further .
- If the field wiring must cross ac or power cables, ensure that they cross at right angles.

To wire your module, follow these steps:

- 1 Determine the length of cable you need to connect a channel to its field device. Remember to include additional cable to route the drain wire and foil shield to their ground points.

2. At each end of the cable, strip some casing to expose the individual wires.
3. Trim the exposed signal wires to 2 in. lengths. Strip about 3/16 in. (about 5 mm) of insulation away to expose the end of each wire.
4. At one end of the cable, twist the drain wire and foil shield together, bend them away from the cable, and apply shrink wrap.

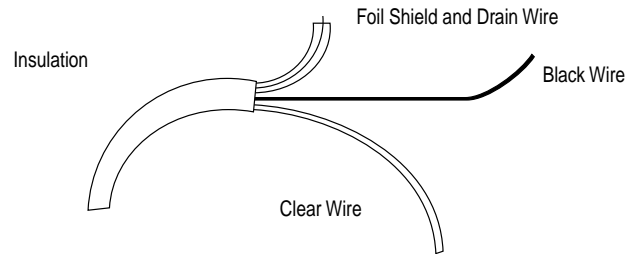

5. At the other end of the cable, cut the drain wire and foil shield back to the cable and apply shrink wrap.

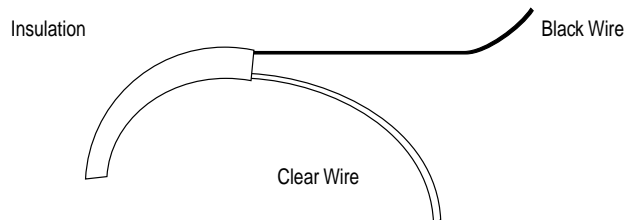

6. Connect the wires to the terminal block and field device as shown in the following figures and table. The recommended maximum torque is 5 in-lb (0.565 Nm) for all terminal screws.

To guard against electrostatic damage and improve chassis grounding, connect one of the shield pins on the terminal block of your module to the chassis itself

Important: For CE compliance, Ferrite EMI Suppressors are needed on each channel's terminal block connection. Apply the suppressor close to the module terminal block, as shown below. A Steward Part 28B2024-0A0 or equivalent is recommended. The Steward 28B2024-0A0 has an impedance of 157 Ω at 25 MHz, 256 Ω at 100 MHz, and can accommodate one turn of wire.

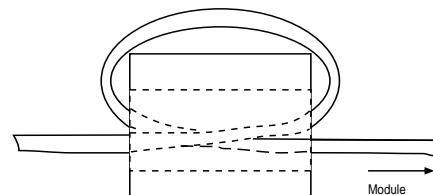

7. Repeat steps 1 through 6 for each channel on your module.

A system may malfunction due to a change in its operating environment. After installing and wiring your module, check system operation. See the system *Installation and Operation Manual* for more information.

Figure 1. Wiring diagrams (showing differential inputs).

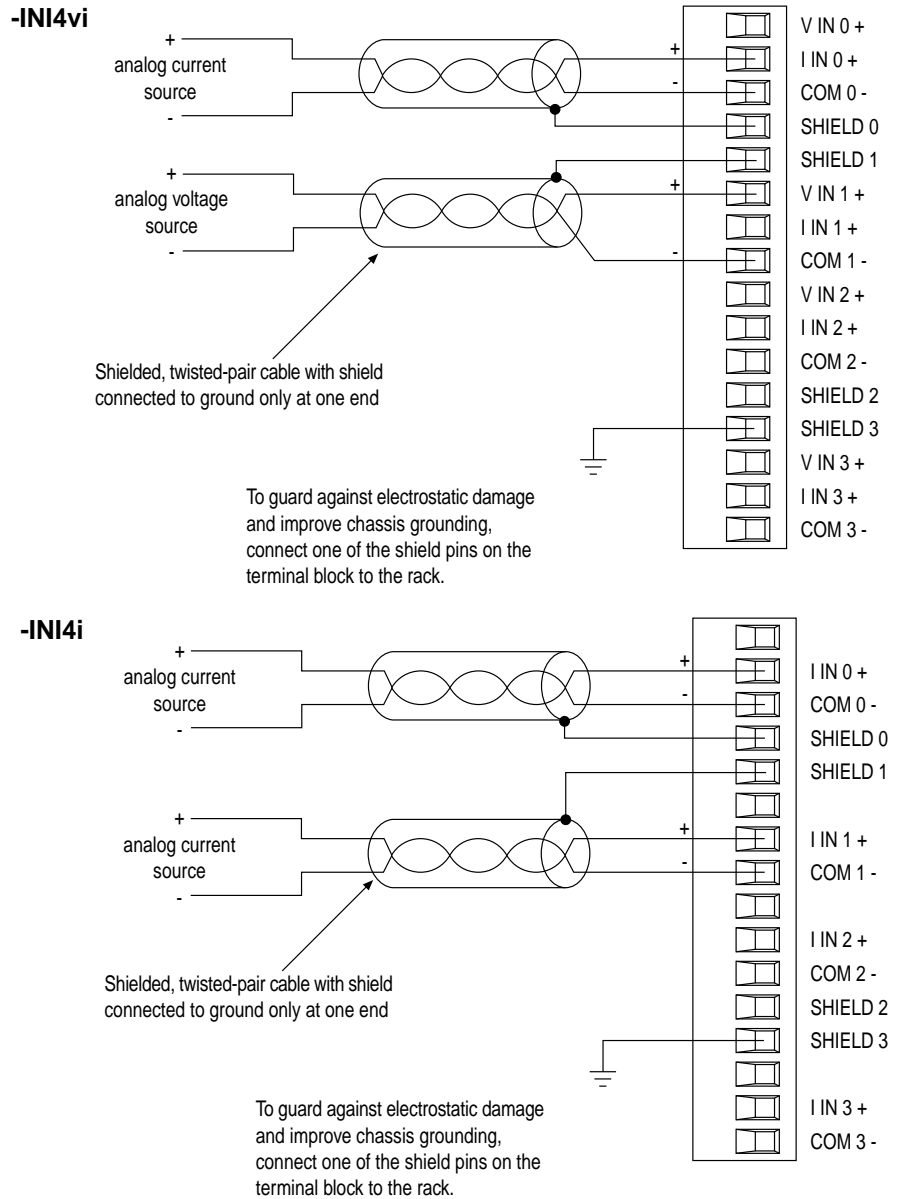

Table 7. Input module terminal block connections.

Pin	Label	Function	Channel
0	V IN 0 +	High differential voltage input (-INI4vi only)	0
1	I IN 0 +	High differential current input	
2	COM 0 -	Low differential input, voltage & current, analog ground	
3	SHIELD 0	Chassis ground	
4	SHIELD 1	Chassis ground	1
5	V IN 1 +	High differential voltage input (-INI4vi only)	
6	I IN 1 +	High differential current input	
7	COM 1 -	Low differential input, voltage & current, analog ground	
8	V IN 2 +	High differential voltage input (-INI4vi only)	2
9	I IN 2 +	High differential current input	
10	COM 2 -	Low differential input, voltage & current, analog ground	
11	SHIELD 2	Chassis ground	
12	SHIELD 3	Chassis ground	3
13	V IN 3 +	High differential voltage input (-INI4vi only)	
14	I IN 3 +	High differential current input	
15	COM 3 -	Low differential input, voltage & current, analog ground	

The shields are all internally connected to chassis ground through high-voltage capacitors.

Figure 2. Wiring schematic for 2-, 3-, and 4-wire analog inputs

Important: Your module does *not* provide power for analog inputs. Use a power supply that matches the transmitter specifications.

2-Wire Transmitter

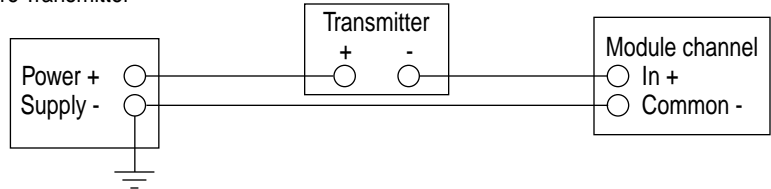

3-Wire Transmitter

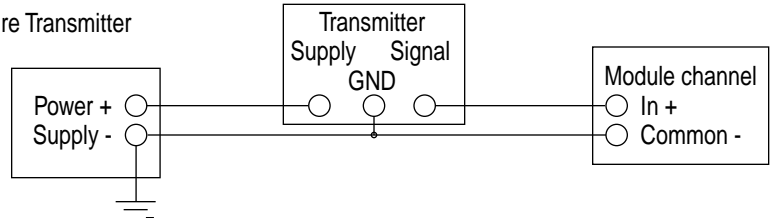

4-Wire Transmitter

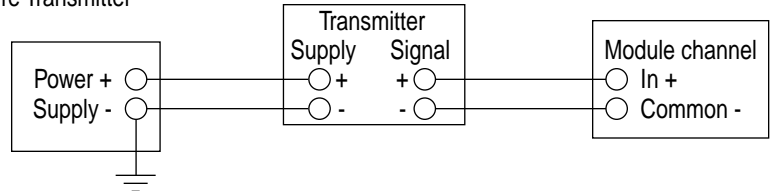
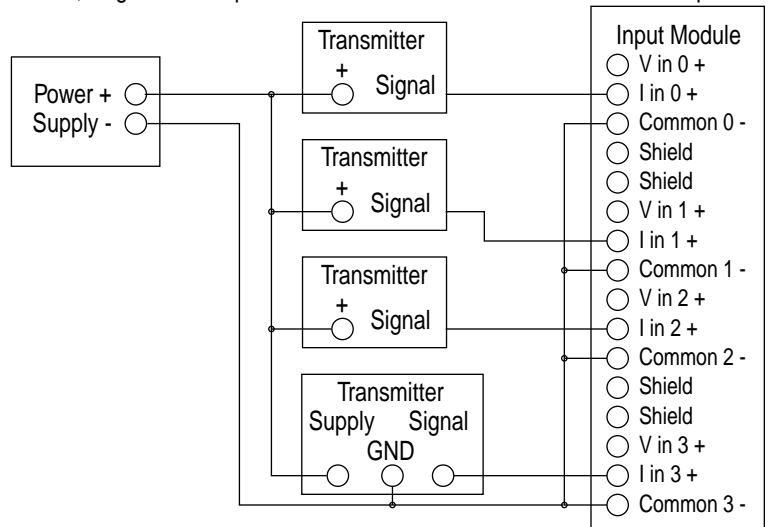

Figure 3. Wiring schematic for single-ended analog inputs

Important: With single-ended inputs, the channels are not isolated from each other. Also, single-ended inputs are less immune to noise than differential inputs.



Things To Consider Before Using Your Module

Read this chapter to familiarize yourself with:

- how the processor communicates with your module
- the difference between channel update time and step response time
- selecting an input filter frequency
- auto-calibration time
- channel enable and disable times
- your module's response to slot disabling

How The Processor Communicates With Your Module

Your processor transfers data to (and receives data from) the processor through an image table residing in the data files of your processor. The processor updates this image table once during each scan of your ladder program. Figure 4 shows the output and input image table for your input module.

Figure 4. Image table for your isolated analog input module

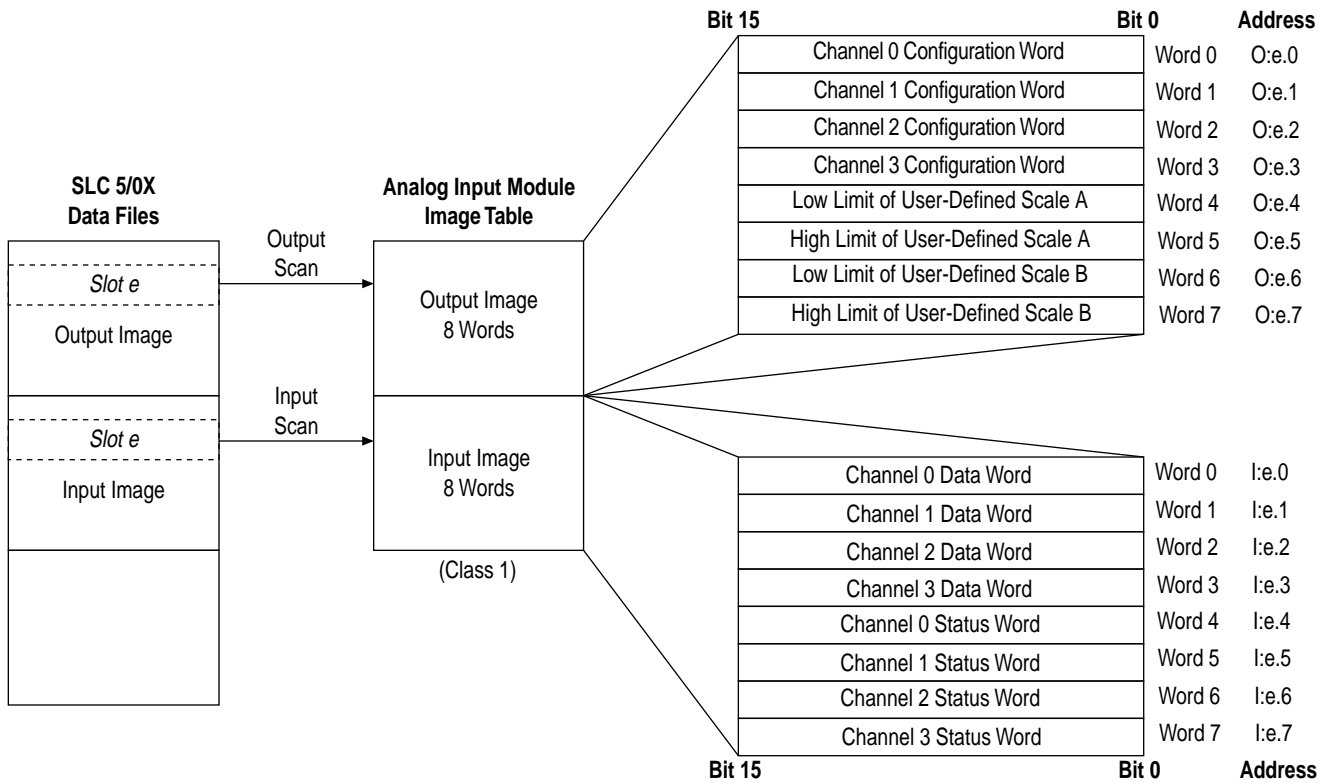

Example – If you want to reconfigure channel 2 on your input module, and it is in slot 4 of the SLC chassis, you would modify the configuration word at address O:4.2. Alternatively, if you want to obtain the status of channel 2, you would check the status word at address I:4.6.

The output and input image are described below.

Output Image—Configuration & User-Defined Scale Limits

The 8-word, output image (defined as the output from the SLC processor to your module) defines how each channel on your module works:

- The **configuration words** replace configuration DIP switches on your module. Each word configures a single channel.
- The **user-defined scale limits** define how your module scales analog input values to a binary input register value, if one of the user-defined scale data formats is selected.

Input Image—Data And Status Words

The 8-word, input image (defined as the input from your module to the SLC processor) holds the data received by your module and provides the status (configuration and operational state) of each channel.

Important – A data word is valid only when the channel is enabled and there are no channel errors. A status word is valid only when the channel is enabled and the module has processed all configuration changes.

The Difference Between Channel Update Time & Step Response Time

The speed of an analog module can be defined in 2 distinctly different ways: either by the channel update time or by the full-scale step response time.

- The **channel update time** is the time required for your module to sample and convert the input signal of an enabled channel and make the resulting data available to the processor.
- The **full-scale step response time** is the time required for a channel's data word to reach 95% of the expected, final value, given a full-scale step change in the input signal. This means that if an input signal changes faster than the full-scale step response time, the signal value provided to the processor has not reached 95%.

Figure 5 illustrates the difference between channel update time and full-scale step response time:

Figure 5. Channel update time and full-scale step response time

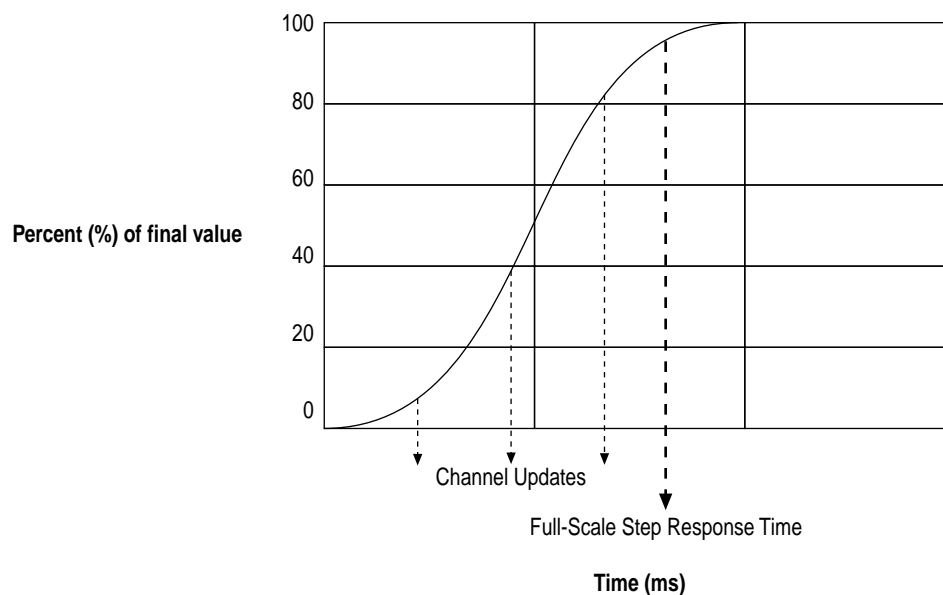

The actual channel update time and full-scale step response time depend on a number of things, such as the filter frequency selected. Because of this, the number of channel updates that can occur before the channel data word reaches 95% of its expected value can vary.

In general, you can reduce the channel update time by doing any of the following:

- disabling unused channels
- selecting a higher frequency input filter

You can reduce the full-scale step response time by:

- selecting a higher frequency input filter

Note, however, that selecting a higher frequency input filter decreases the noise rejection and effective resolution, as described in the next subsection, “Selecting An Input Filter Frequency.”

For the fastest possible channel update time, enable only one channel and select a 250 or 500 Hz filter. Conversely, your module operates most slowly if you enable all 4 channels and select a 50 Hz filter for each.

Selecting An Input Filter Frequency

The 1746sc-INI4i and 1746sc-INI4vi input modules use a digital filter to reject the high-frequency noise that can couple into an analog input signal. This digital filter is programmable, letting you select one of four filter frequencies for each channel. The digital filter provides the highest noise rejection at the selected filter frequency. For example, to reject the noise associated with 60 Hz power, you may want to select the 60 Hz filter.

The filter frequency you select determines that channel’s 3 dB cut-off frequency, full-scale step response time, worst-case effective resolution, and channel update time, as shown in Tables 8 and 9.

Table 8. Cut-off frequency, step response time, & effective resolution (based on filter frequency)

Filter	3 dB Cut-Off	Full-Scale Step Resp.	Worst-Case Effective Res. ^①	
			Voltage Mode	Current Mode
50 Hz	13.1 Hz	80 ms	12 bits	11 bits
60	15.7	66.7	12	11
250	65.5	16	11.5	10.5
500	131	8	9.5	9.5

^① For a 16-bit device like the 1746sc-INI4i and -INI4vi, a worst-case effective resolution of 12 bits means that the data may fluctuate by as much as 16 counts (4 bits).

Typically, the effective resolution is greater than that listed here.

**Table 9. Channel update time
(based on number of channels enabled and filter frequency)**

	# of ch. enabled	Filter Frequency			
		50 Hz	60 Hz	250 Hz	500 Hz
Current Input	1	20.0 ms	16.6 ms	4.0 ms	4.1 ms
	2	20.5	17.7	7.3	7.3
	3	19.8	16.6	10.6	10.7
	4	21.0	17.0	13.8	13.8
Voltage Input (-INI4vi only)	1	19.7 ms	16.6 ms	5.0 ms	5.0 ms
	2	19.7	17.2	9.2	9.2
	3	19.7	16.6	13.5	13.5
	4	19.7	18.0	18.0	18.0

The 3 dB cut-off frequency is the frequency at which input signals are passed with 3 dB of attenuation.

Choose a filter frequency so that the frequency of your fastest changing signal is lower than that filter's 3 dB cut-off frequency. All frequency components above the 3 dB cut-off frequency are increasingly attenuated, as shown in the following figures.

Figure 6. Signal attenuation with 50 Hz input filter

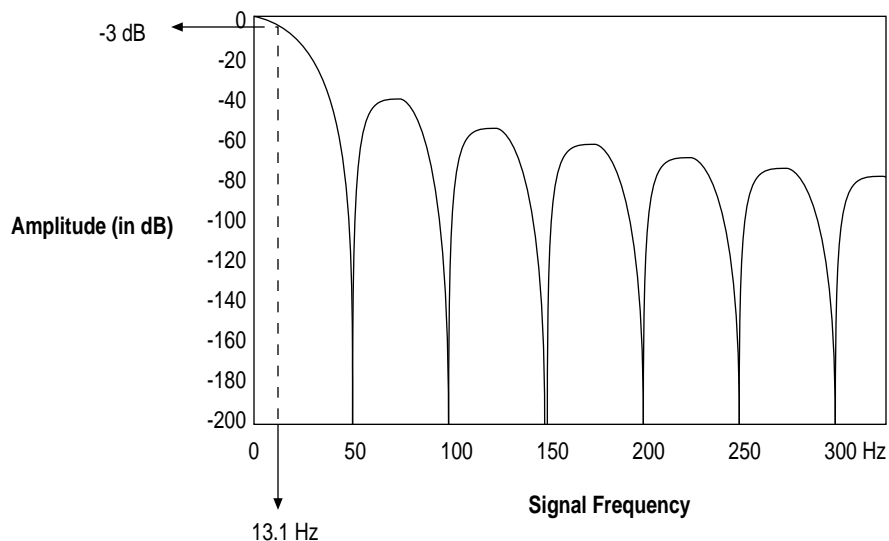

Figure 7. Signal attenuation with 60 Hz input filter

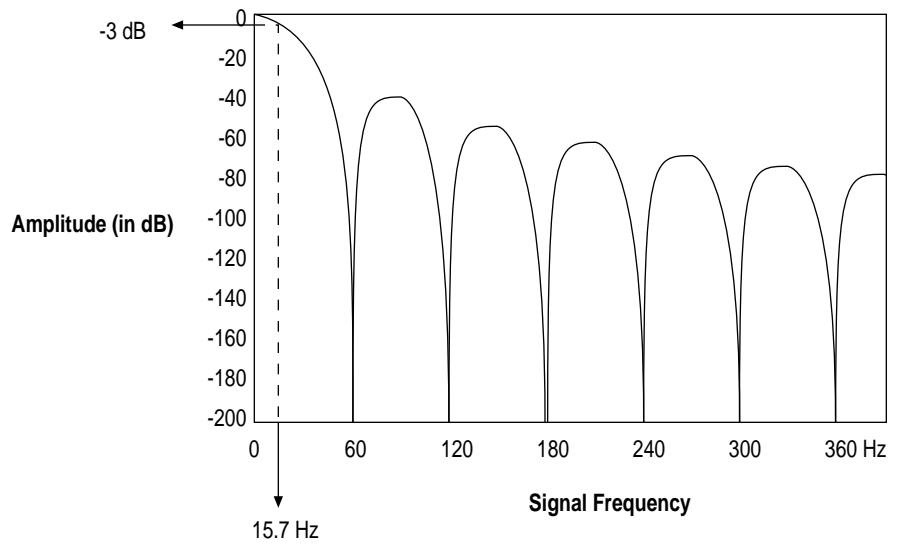

Figure 8. Signal attenuation with 250 Hz input filter

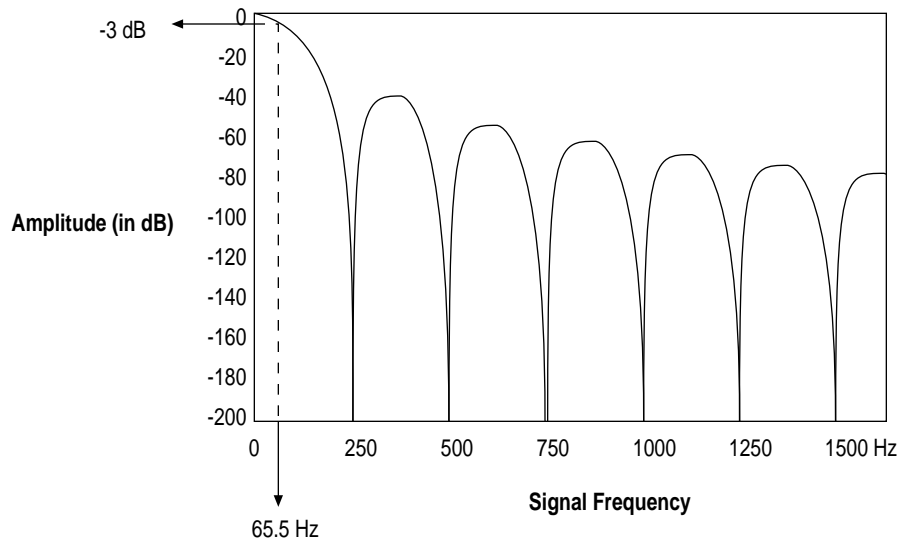
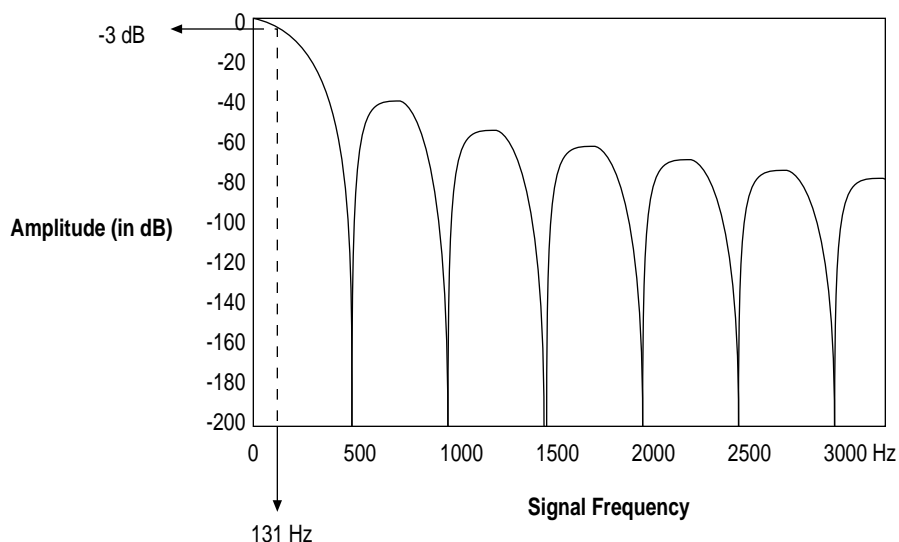

Figure 9. Signal attenuation with 500 Hz input filter

Auto-Calibration Time

Your module requires some time to auto-calibrate a channel. During this time, your module cannot sample and convert input signals. Table 10 shows the time required for auto-calibration. When enabled, auto-calibration occurs every 10 seconds for each channel, independently.

Table 10. Auto-calibration time per channel (based on filter frequency)

	Filter Frequency			
	50 Hz	60 Hz	250 Hz	500 Hz
Current Input	182 ms	152 ms	39 ms	19.6 ms
Voltage Input (-INI4vi only)	508	430	108	56

Channel Enable And Disable Times

Your module requires some time to enable or disable a channel. During this time, your module cannot sample and convert input signals. Table 11 shows the time required for enabling or disabling a channel.

Table 11. Channel enable and disable times.

	Duration
Channel Enable	Up to 6.5 ms Enabling user-defined scaling may require an additional 0.1 ms.
Channel Disable	Up to 5.5 ms

Your Module's Response To Slot Disabling

By writing to the status file in the modular SLC processor, you can disable any chassis slot. Refer to your SLC programming manual for the slot disable/enable procedure.



CAUTION

POSSIBLE EQUIPMENT OPERATION

Always understand the implications of disabling a module before using the slot disable feature.

Failure to observe this precaution can cause unintended equipment operation.

When you disable an input module's slot, the input data in the processor image table remains in its last state. When you re-enable the input module's slot, the processor image table is updated during the next scan.

Using Your Input Module

Read this chapter to:

- enter your input module's ID code
- configure each input channel
- set the user-defined scale limits (optional)
- monitor each input channel
- check each input channel's configuration and status

To use your module, you need:

- programming equipment, such as an Allen-Bradley Hand-Held Terminal (HHT) or personal computer
- Allen-Bradley Advanced Programming Software (APS) or equivalent

For help with APS, see the *Getting Started Guide for APS*.

Entering Your Module's ID Code

Before using your module, you must configure the slot your module is in by entering your module's ID code in APS. To enter your module's ID code, select "other" from the list of modules on the APS system I/O configuration display, and enter your module's ID code at the prompt. The module ID code for your input module is:

Table 12. Module ID codes

Catalog Number	Module ID Code
1746sc-INI4i	3522
1746sc-INI4vi	3520

No special I/O configuration (SPIO CONFIG) information is required. The module ID code automatically assigns the correct number of input and output words for the processor to access.

Configuring Each Input Channel

After installing your module, you must configure each channel by setting bit values in each configuration word. Output words 0 through 3 of the output image file (addresses O:e.0 through O:e.3) configure channels 0 through 3, respectively.

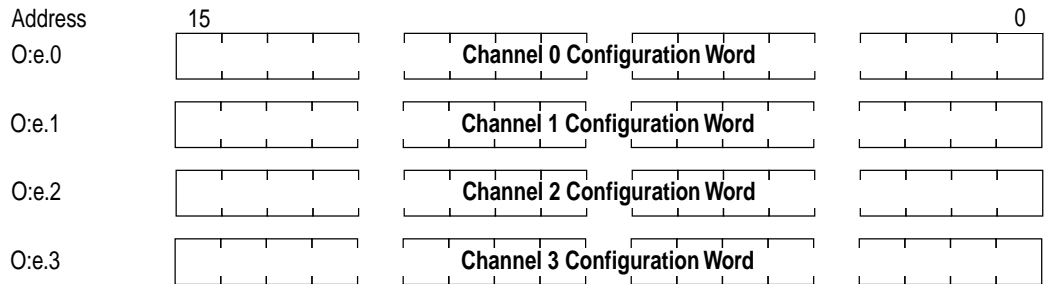

Important - After reconfiguring a channel, you must toggle the channel enable bit (configuration bit 0) in order for your module to use the new configuration.

A detailed explanation appears in the following table:

Table 13. Input channel configuration word (O:e.0 through O:e.3)

To select...	Use these bit settings in the channel configuration word																
	15	14	13	12	11	10	9	8	7	6	5	4	3	2	1	0	
Input channel disable																	0
Input channel enable																	1
±10 Vdc input range (-INI4vi only)													0	0	0		
1–5 Vdc input range (-INI4vi only)													0	0	1		
0–5 Vdc input range (-INI4vi only)													0	1	0		
0–10 Vdc input range (-INI4vi only)													0	1	1		
0–20 mA input range													1	0	0		
4–20 mA input range													1	0	1		
Invalid													1	1	0		
Invalid													1	1	1		
Engineering units										0	0	0					
Scaled for PID										0	0	1					
Proportional counts										0	1	0					
1746-NI4 compatible format										0	1	1					
User-defined scale A										1	0	0					
User-defined scale B										1	0	1					
Invalid										1	1	0					
Invalid										1	1	1					
Zero on open input circuit ^①										0	0						
Max. on open input circuit ^①										0	1						
Min. on open input circuit ^①										1	0						
Invalid										1	1						
60 Hz input filter						0	0										
50 Hz input filter						0	1										
150 Hz input filter						1	0										
500 Hz input filter						1	1										
Auto-calibration disabled							0										
Auto-calibration enabled							1										
Unused	0	0	0	0													
Invalid	1	1	1	1													

^① Applies only to the 1–5 Vdc and 4–20 mA input ranges.

Input Channel Enable (configuration bit 0)

Use this bit to enable or disable a channel. To minimize update times, disable any unused channels.

When you set the channel enable bit to one, the module reads the configuration word. Before accepting any new data as valid, verify that the status word (described in the last subsection of this chapter) reflects the changes you made.

While the channel enable bit is set to zero, the channel data word and status word are also set to zero. When you reset the channel enable bit to one, the channel data word remains set to zero until your module updates the channel status word.

Input Range (configuration bits 1–3)

Use this bit field to configure the channel for the type of input device you want to connect to your module.

Data Format (configuration bits 4–6)

Use this bit field to select one of the following formats:

- engineering units (mV or nA)
- scaled for PID (works with the SLC PID instruction)
- proportional counts (two's complement binary)
- 1746-NI4 compatible format (the format used by the 1746-NI4)
- user-defined scale A
- user-defined scale B

These data formats are defined in the following table:

Table 14. Data format definitions

Data Format	Selected Input Range	Actual Signal Limits		Count Limits	
		Min.	Max.	Min.	Max.
Engineering Units	±10 V	-10.25 V	+10.25 V	-10250	+10250
	0–10 V	-0.50 V	+10.25 V	-500	+10250
	0–5 V	-0.50 V	+5.50 V	-500	+5500
	1–5 V	+0.50 V	+5.50 V	+500	+5500
	0–20 mA	0.0 mA	+20.5 mA	0	+20500
	4–20 mA	+3.5 mA	+20.5 mA	+3500	+20500
Scaled for PID ③	±10 V	-10 V	+10 V	0	+16383
	0–10 V	0 V	+10 V	0	+16383
	0–5 V	0 V	+5 V	0	+16383
	1–5 V	+1 V	+5 V	0	+16383
	0–20 mA	0 mA	+20 mA	0	+16383
	4–20 mA	+4 mA	+20 mA	0	+16383
Proportional Counts	±10 V	-10.25 V	+10.25 V	-32768	+32767
	0–10 V	-0.50 V	+10.25 V	-32768	+32767
	0–5 V	-0.50 V	+5.50 V	-32768	+32767
	1–5 V	+0.50 V	+5.50 V	-32768	+32767
	0–20 mA	0.0 mA	+20.5 mA	-32768	+32767
	4–20 mA	+3.5 mA	+20.5 mA	-32768	+32767
1746-NI4-compatible①	±10 V	-10 V	+10 V	-32768	+32767
	0–10 V	0 V	+10 V	0	+32767
	0–5 V	0 V	+5 V	0	+16384
	1–5 V	+1 V	+5 V	+3277	+16384
	0–20 mA	0 mA	+20 mA	0	+16384
	4–20 mA	+4 mA	+20 mA	+3277	+16384
User-defined scale A (and B)	±10 V	-10.25 V	+10.25 V		
	0–10 V	-0.50 V	+10.25 V		
	0–5 V	-0.50 V	+5.50 V		See note ②.
	1–5 V	+0.50 V	+5.50 V		
	0–20 mA	0.0 mA	+20.5 mA		
	4–20 mA	+3.5 mA	+20.5 mA		

① Provides direct compatibility with the 1746-NI4 module.

② For user-defined scale A (or B), the data in output words 4 and 5 (or 6 and 7) determine the count limits. See the next subsection, *Setting The User-Defined Scale Limits*, for information on the User-Defined Scale data format.

③ **Note:** Modules marked Series B Revision 1.00 or earlier had different signal limits for the Scaled for PID data format (see the Owner's Guide that came with your module).

Open Input Circuit Response (configuration bits 7 and 8)

For 1–5 Vdc and 4–20 mA inputs only, use this bit field to define the state of the channel data word when your module detects an open circuit for that channel:

- If you select **zero on open input circuit**, your module sets the channel data word to zero during an open circuit condition.
- If you select **max. on open input circuit**, your module sets the channel data word to its full-scale value during an open circuit.
- If you select **min. on open input circuit**, your module sets the channel data word to its low-scale value during an open circuit.

The full-scale and low-scale values (max. and min. count limits) are determined by the channel's data format and selected input range. See Table 14.

Important – If a circuit opens, your module provides input signal values until it detects and flags the open circuit.

Input Filter Frequency (configuration bits 9 and 10)

Use this bit field to select one of four filters for a channel. The filter selected affects the channel update time and noise rejection characteristics:

- A **lower** filter frequency increases the noise rejection and effective resolution, but it also increases the channel update time.
- A **higher** filter frequency decreases the update time, but it also decreases the noise rejection and effective resolution.

Refer to Chapter 3, *Things To Consider Before Using Your Module*, for more information on selecting a filter frequency.

Auto-Calibration Enable (configuration bit 11)

Use this bit to enable or disable auto-calibration. When enabled, auto-calibration occurs every 10 seconds. Auto-calibration also occurs whenever you configure a channel (regardless of the setting of this bit).

Unused Bits (configuration bits 12–15)

These bits are not defined. To prevent a configuration error, ensure that bits 12 through 15 are set to zero.

Setting The User-Defined Scale Limits (optional)

For special applications (such as when using a sensor with a non-standard operating range), the 1746sc-INI4i and 1746sc-INI4vi input modules let you define up to two custom data formats. These “user-defined scales” are very similar to the “proportional counts” data format provided by your module and many Allen-Bradley modules—except that instead of scaling the input signal to a previously defined range (-32,768 to +32,767), your module can scale the input signal to a range defined by the values in output words 4 and 5 (for user-defined scale A) or output words 6 and 7 (for user-defined scale B).

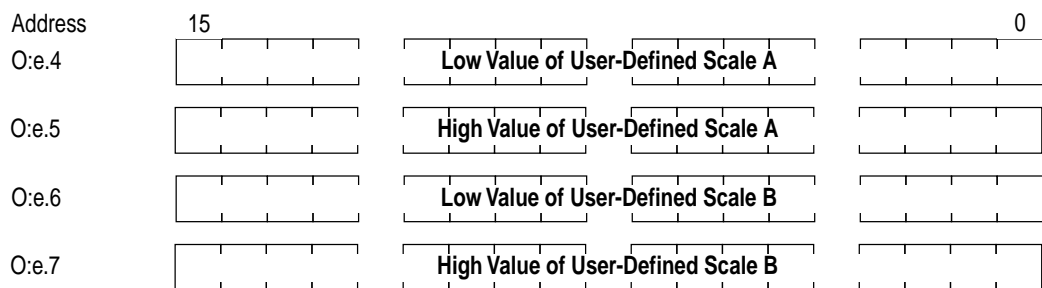

Important - After setting user-defined scale limits, you must toggle the channel enable bit (configuration bit 0) in order for your module to use the new limits.

Output word 4 (or 6) defines the low limit of the user-defined scale (down to -32768), while output word 5 (or 7) defines the high limit of the user-defined scale (up to +32767). The high limit value must be greater than the low limit value for proper operation.

You select the data format for each channel using that channel’s configuration word, described in the previous subsection, *Configuring Each Input Channel*.

The following equations show you how to convert user-defined scale units (or any type of units) to engineering units, and vice versa:

$$S = \{(U - U_{\text{low}}) \times (\Delta S) \div (\Delta U)\} + S_{\text{low}}$$

$$D = \{(S - S_{\text{low}}) \times (\Delta U) \div (\Delta S)\} + U_{\text{low}}$$

where S = signal value (in engineering units, such as psi)

S_{low} = low limit of signal value

S_{high} = high limit of signal value

$$\Delta S = S_{\text{high}} - S_{\text{low}}$$

D = data value (user-defined scale)

U_{low} = low limit of user-defined scale

U_{high} = high limit of user-defined scale

$$\Delta U = U_{\text{high}} - U_{\text{low}}$$

Example – Suppose you have a sensor with a 4–20 mA range, and you want to scale your data from 100 to 9999 counts. For a 4–20 mA input with user-defined scaling, your module sets the signal limits to 3.5 mA and 20.5 mA (see Table 14). After entering 100 and 9999 into output words 4 and 5 (or 6 and 7), respectively, the relationship between input signal and data value (counts) would be as follows:

Figure 10. Graph of signal value vs data value

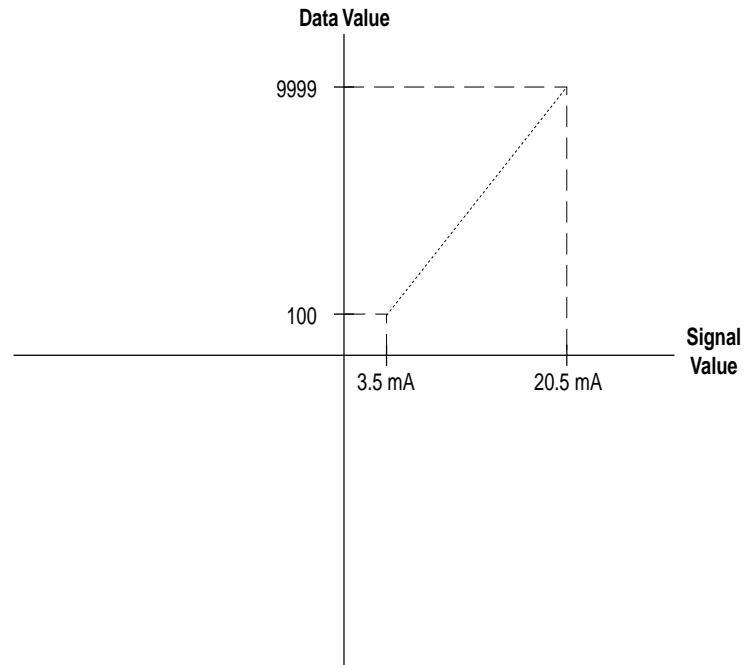

In the preceding example...

$$S_{\text{low}} = 3.5$$

$$U_{\text{low}} = 100$$

$$S_{\text{high}} = 20.5$$

$$U_{\text{high}} = 9999$$

$$\Delta S = 17$$

$$\Delta U = 9899$$

Monitoring Each Input Channel

The input signal data resides in words 0 through 3 of the input image file (addresses I:e.0 through I:e.3). The values present depend on the input types and data formats selected. When an input channel is disabled, its data word is set to zero.

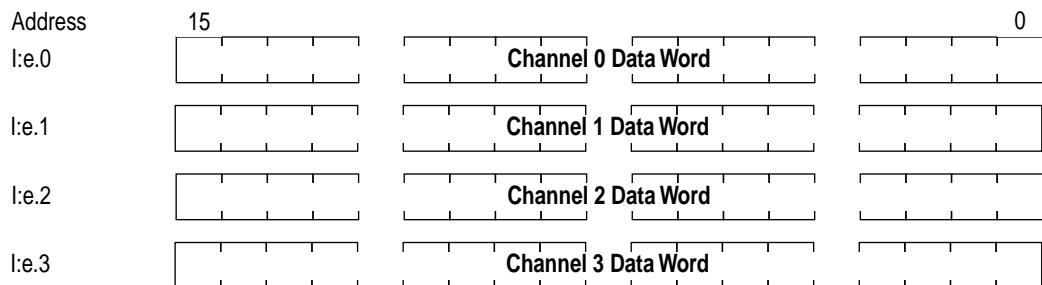

Checking Each Input Channel's Configuration And Status

Words 4 through 7 of the input image file (addresses I:e.4 through I:e.7) reflect the configuration and status of each channel. Use the data provided in these status words to determine if the configuration data for any channel is valid.

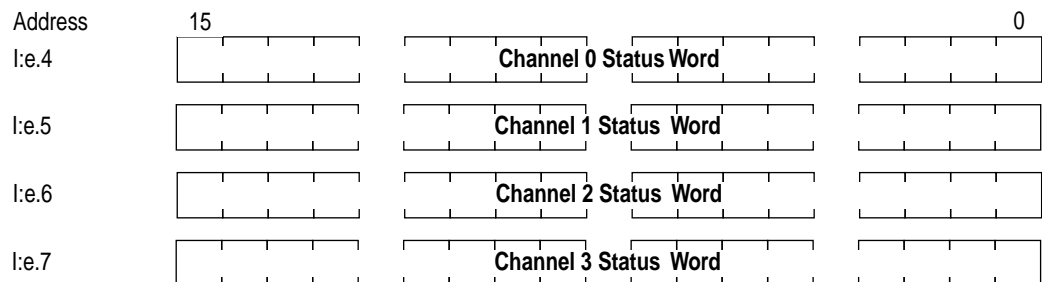

Whenever a channel is disabled, its status word is set to zero. This condition tells you that input data in the data word for that channel is not valid and should be ignored.

A detailed explanation appears in Table 15.

Table 15. Input channel status word (I:e.4 through I:e.7)

These bit settings in the status word															Indicate this	
15	14	13	12	11	10	9	8	7	6	5	4	3	2	1	0	
															0	Input channel disabled
															1	Input channel enabled
												0	0	0		±10 Vdc input range
												0	0	1		1–5 Vdc input range
												0	1	0		0–5 Vdc input range
												0	1	1		0–10 Vdc input range
												1	0	0		0–20 mA input range
												1	0	1		4–20 mA input range
									0	0	0					Engineering units
									0	0	1					Scaled for PID
									0	1	0					Proportional counts
									0	1	1					1746-NI4 format
									1	0	0					User-defined scale A
									1	0	1					User-defined scale B
							0	0								Zero on open input circuit
							0	1								Max. on open input circuit
							1	0								Min. on open input circuit
					0	0										60 Hz input filter
					0	1										50 Hz input filter
					1	0										150 Hz input filter
					1	1										500 Hz input filter
				0												Auto-calibration disabled
				1												Auto-calibration enabled
			0													No error
			1													Over-range error
		0														No error
		1														Under-range error
	0															No error
	1															Non-fatal channel error
0																No error
1																Fatal channel error

The first 12 status bits reflect the settings in the channel configuration word. The remaining status bits flag the various errors that the module can detect.

Over-Range Error (status bit 12)

This bit is set to one whenever your module detects an over-range condition for a configured channel. An over-range condition exists when the input value is very near or above the upper limit for that channel's data format (see Table 14).

Under-Range Error (status bit 13)

This bit is set to one whenever your module detects an under-range condition for a configured channel. An under-range condition exists when the input value is very near or below the lower limit for that channel's data format (see Table 14).

Non-Fatal Channel Error (status bit 14)

This bit is set to one whenever your module detects a recoverable channel error, such as an invalid configuration word for that channel. This bit is reset to zero when the error is resolved.

Fatal Channel Error (status bit 15)

This bit is set to one whenever your module detects a "non-recoverable" channel error, such as a software power-up failure due to corrupt hardware or malfunctioning software. You may be able to recover from this type of error by resetting the SLC 500 processor or cycling power to your module.

Programming Examples

Read this chapter to familiarize yourself with how to use the advanced features of your module for:

- PID control
- user-defined scaling

For information on how to use the Allen-Bradley Advanced Programming Software (APS) to create ladder programs, see the *Getting Started Guide For APS*.

PID Control

Your input module was designed to work directly with the SLC 5/02, 5/03, and 5/04 PID instruction—without an intermediate scaling operation. Use the input channel data as the process variable in the PID instruction.

Example — Suppose your input module is in slot 3, and you have a level sensor with a 4–20 mA range connected to channel 0. The following figures show you how to use it for PID control:

Figure 11. PID control example.

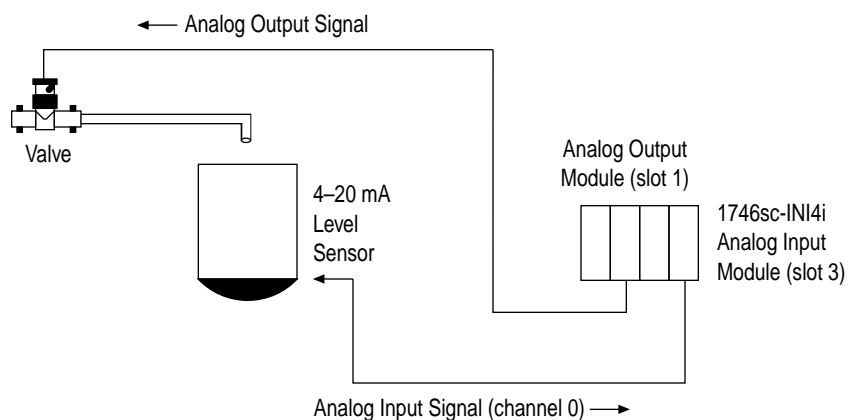

Figure 12. Programming for PID control example.

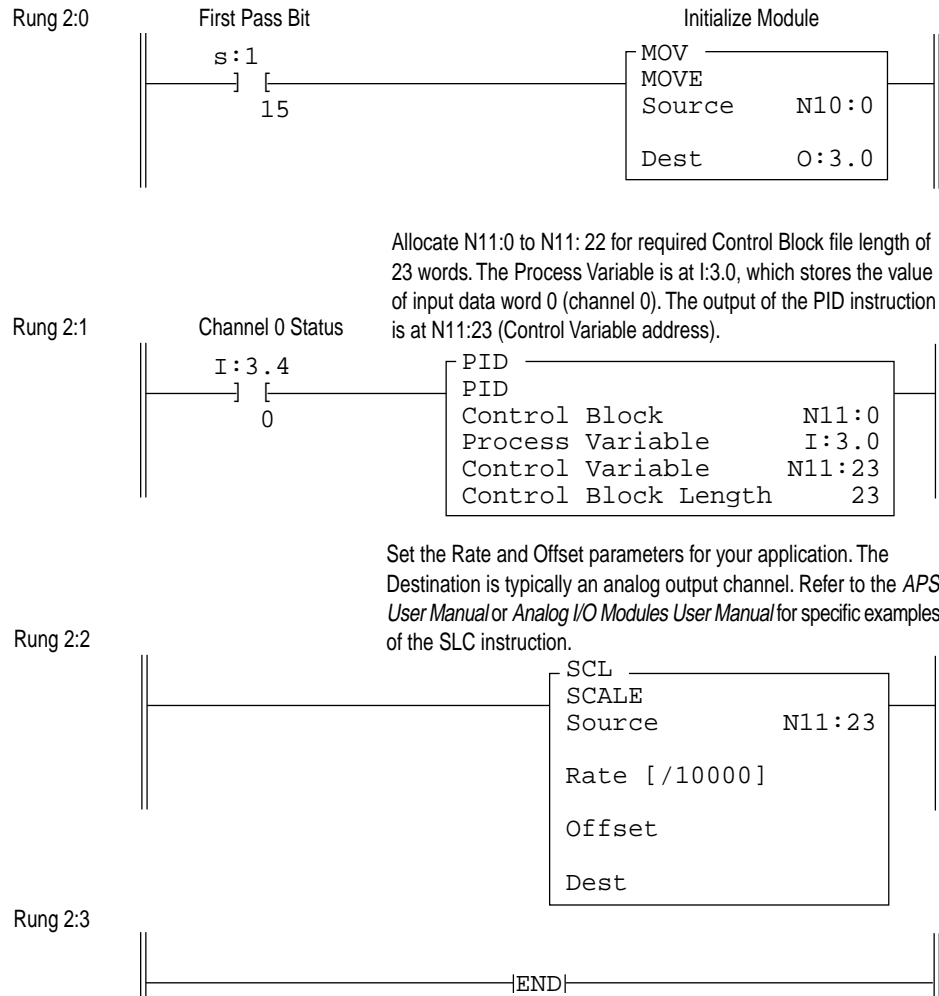

Figure 13. Data table for PID control example.

address	15	data	0	address	15	data	0
N10:0	0000	0000	0001 1011				

Important — When using your module’s *Scaled For PID* data format with the SLC PID function, ensure that the *Maximum Scaled S_{max}* (word 7) and *Minimum Scaled S_{min}* (word 8) PID instruction parameters match your module’s maximum and minimum scaled range in engineering units for that channel. This allows you to accurately enter the setpoint in engineering units.

User-Defined Scaling

Your input module was designed to work directly with applications requiring special data scaling—without an intermediate scaling operation.

Example — Suppose your input module is in slot 3, and you have a pressure sensor with a 4–20 mA range connected to channel 0. The following figures show you how to use the *User-Defined Scaling* data format to send specially scaled data (100 to 9999 in this example) to a simple display-only operator interface:

Figure 14. User-defined scaling example.

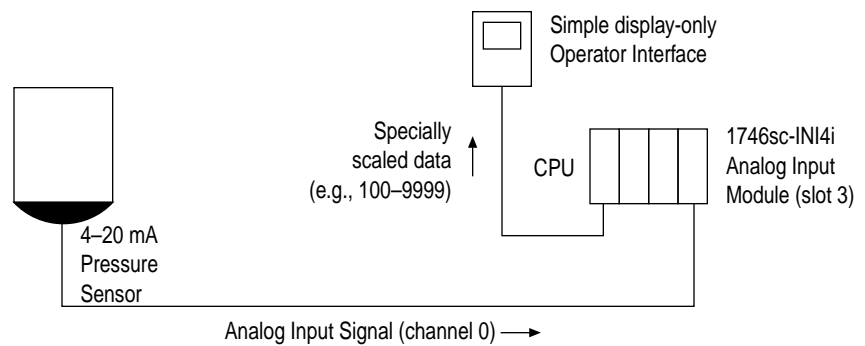

Figure 15. Programming for user-defined scaling example.

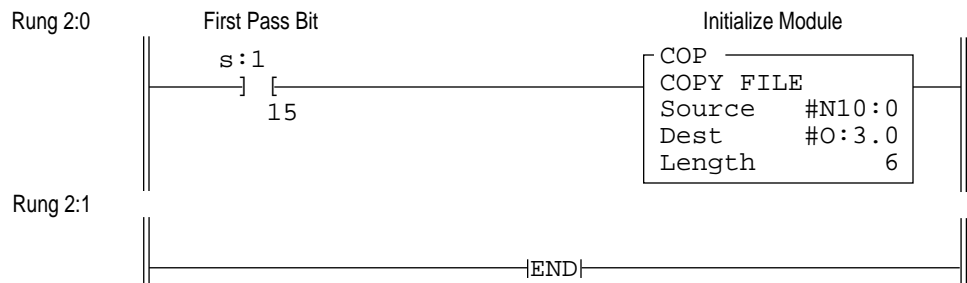

Figure 16. Data table for user-defined scaling example.

address	15	data	0	address	15	data	0
N10:0	0000	0000	0100 1011	N10:3	0000	0000	0000 0000
N10:1	0000	0000	0000 0000	N10:4	0000	0000	0110 0100 (100 gallons)
N10:2	0000	0000	0000 0000	N10:5	0010	0111	0000 1111 (9999 gallons)

In this example, the operator interface is programmed to read I:3.0 (channel 0 data word).

Testing Your Module

Read this chapter to prevent potential problems in a systematic and controlled way. This chapter covers:

- inspecting your module
- disconnecting prime movers
- powering up
- interpreting the LED indicators
- interpreting I/O error codes
- troubleshooting

Before testing your module, test your SLC 500 system using the procedures described in your system's *Installation & Operation Manual*.

Inspecting Your Module

You can prevent many potential problems by simply inspecting your analog module:

1. Ensure that all wire connections are correct and secure and that no wires are missing or broken.



CAUTION

FIELD WIRING ERRORS

Before enabling a channel (through your ladder program), ensure that you have not connected a voltage source to a channel configured for a current input (and vice versa).

Failure to observe this precaution can cause improper module operation or equipment damage.

2. Ensure that the shield for the cable used to wire your module is properly grounded. Refer to Chapter 2, *Installing And Wiring Your Module*, for more information.
3. Ensure that the removable terminal block on your module is secure.

Disconnecting Prime Movers

Before testing your module, ensure that machine motion will not occur:

- Disconnect motor wires at the motor starter or the motor itself. This lets you test the operation of the starter coil, verifying that the output circuit is wired correctly and functioning.
- Disconnect solenoids by disengaging the solenoid valves, leaving the coils connected.

If you cannot disconnect a device in the preferred way, open the output circuit as close as possible to the motion-causing device.

Example – If you have a relay coil that in turn energizes a motor starter and you cannot disconnect the motor wires, open the circuit at a point between the motor starter and the relay contact.



WARNING

POSSIBLE UNEXPECTED MACHINE MOTION

During all testing, always disconnect all devices that, when energized, might cause machine motion.

Failure to observe this precaution can cause equipment damage or personal injury.

Powering Up

When you apply power to the system, the module status LED should illuminate, indicating that your module is receiving power and has completed its onboard self-test. If the LED does not illuminate after several seconds, your module is not functional. Discontinue testing until you can get the LED to illuminate.

The most probable reasons for the LED not illuminating are:

- The SLC 500 system is not receiving power from its power supply.
- The rack slot where your module is located is defective.
- Your module is defective.

Interpreting The LED Indicators

Your module has five LEDs: four channel status LEDs (numbered 0–3 for channels 0–3, respectively) and one module status LED.

Figure 17. LED block

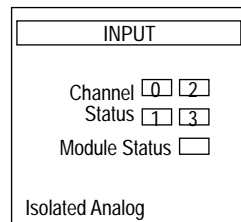

Use the following table to interpret the LEDs:

Table 16. LED definition

If the module status LED is...	And the channel status LED is...	Then...
On	On	The channel is enabled.
	Blinking	One of the following channel errors occurred: <ul style="list-style-type: none"> • circuit open or no wiring is connected • signal is near or beyond end of range • channel configured incorrectly Refer to the following section, <i>Troubleshooting</i> .
	Off	Either your module is powering up or the channel is disabled.
Off	Off	Either the power is off, the module is powering up, or a module fault occurred. Cycle power. If the condition persists, call your local distributor or Spectrum Controls for assistance.

Interpreting I/O Error Codes

I/O error codes appear in word S:6 of the SLC processor status file. The first two digits of the error code identify the slot (in hexadecimal) with the error. The last two digits identify the I/O error code (in hexadecimal).

The error codes that apply to your module include (in hexadecimal):

- 50–5E
- 71 (watchdog error)
- 90–94

For a description of the error codes, refer to the *Allen-Bradley Advanced Programming Software (APS) Reference Manual*, Allen-Bradley publication 1746-6.11.

Troubleshooting

Figure 18. Problem resolution flowchart

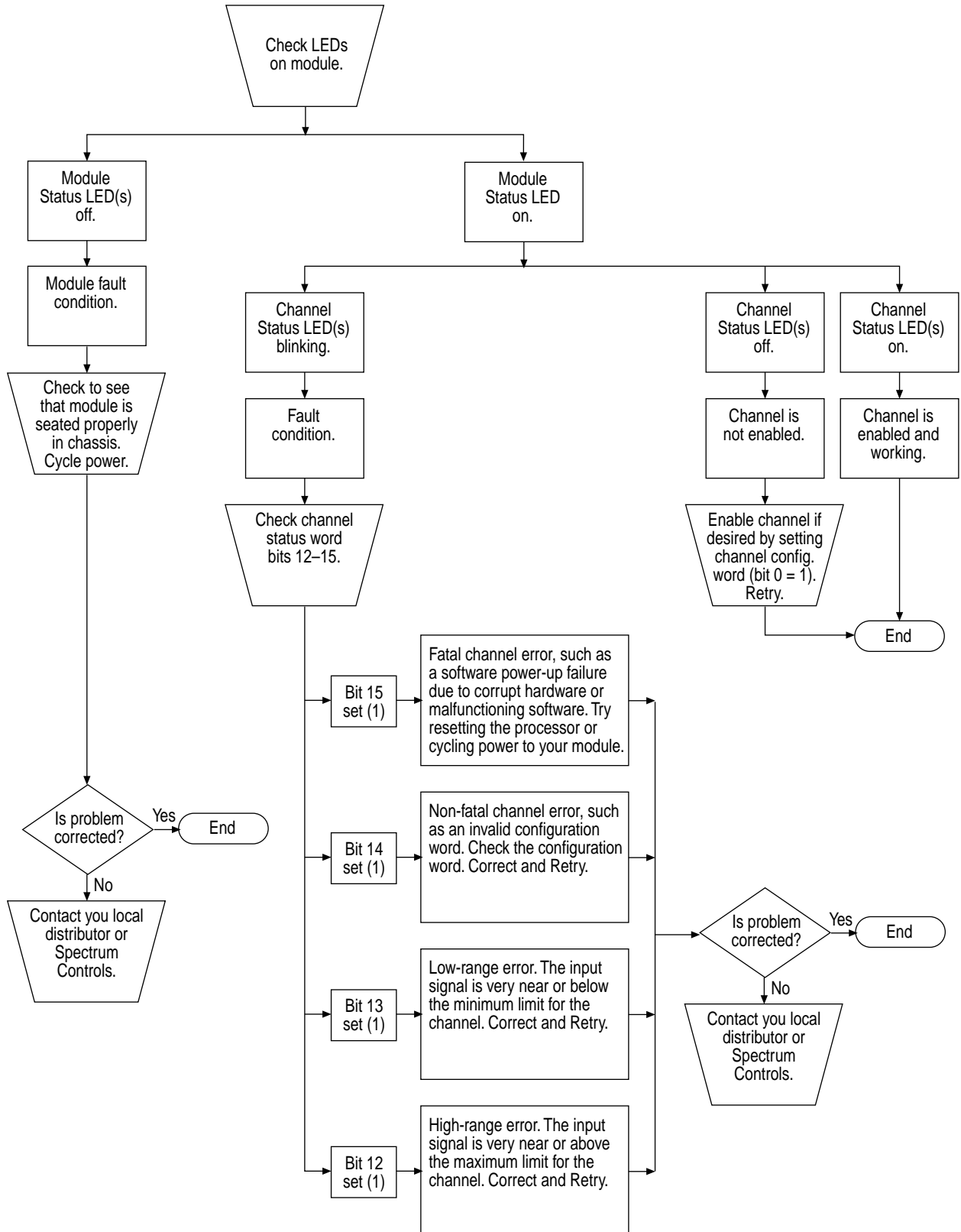

Maintaining Your Module And Ensuring Safety

Read this chapter to familiarize yourself with:

- preventive maintenance
- safety considerations

The National Fire Protection Association (NFPA) recommends maintenance procedures for electrical equipment. Refer to article 70B of the NFPA for general safety-related work practices.

Preventive Maintenance

The printed circuit boards of your module must be protected from dirt, oil, moisture, and other airborne contaminants. To protect these boards, install the SLC 500 system in an enclosure suitable for its operating environment. Keep the interior of the enclosure clean, and whenever possible, keep the enclosure door closed.

Also, regularly inspect the terminal connections for tightness. Loose connections may cause a malfunctioning of the SLC system or damage to the components.



WARNING

POSSIBLE LOOSE CONNECTIONS

Before inspecting connections, always ensure that incoming power is OFF.

Failure to observe this precaution can cause personal injury and equipment damage.

Safety Considerations

Safety is always the most important consideration. Actively think about the safety of yourself and others, as well as the condition of your equipment. The following are some things to consider:

Indicator Lights – When the module status LED on your module is illuminated, your module is receiving power.

Activating Devices When Troubleshooting – Never reach into a machine to activate a device; the machine may move unexpectedly. Use a wooden stick.

Standing Clear Of Machinery – When troubleshooting a problem with any SLC 500 system, have all personnel remain clear of machinery. The problem may be intermittent, and the machine may move unexpectedly. Have someone ready to operate an emergency stop switch.



CAUTION

POSSIBLE EQUIPMENT OPERATION

Never reach into a machine to actuate a switch. Also, remove all electrical power at the main power disconnect switches before checking electrical connections or inputs/outputs causing machine motion.

Failure to observe these precautions can cause personal injury or equipment damage.

Safety Circuits – Circuits installed on machinery for safety reasons (like over-travel limit switches, stop push-buttons, and interlocks) should always be hard-wired to the master control relay. These circuits should also be wired in series so that when any one circuit opens, the master control relay is de-energized, thereby removing power. Never modify these circuits to defeat their function. Serious injury or equipment damage may result.

Refer to your system's *Installation & Operation Manual* for more information.

Verifying Calibration

Read this chapter to verify your module's calibration.

To verify your module's calibration, you need:

- a precision input source whose accuracy is better than or equal to ± 1 mV on a 10 V scale and ± 0.5 μ A on a 20 mA scale (such as an Electronic Development Corporation Programmable IEEE 488 GP-IB DC Calibrator, Model 521)
- programming equipment, such as an Allen-Bradley Hand-Held Terminal (HHT) or personal computer
- Allen-Bradley Advanced Programming Software (APS) or equivalent

Your module automatically calibrates a channel after it is successfully configured. It also calibrates a channel every 10 seconds if auto-calibration is enabled (see Chapter 4). For these reasons, your module should never need calibration. You may, however, want to verify the calibration periodically using the procedures provided in this chapter.

Recommended Schedule

Although not required, you should verify your module's calibration once a year or after any system failure that may have been due to input inaccuracy.

Verifying Current Inputs

1. Configure your module for 0–20 mA input on all 4 channels using the following configuration word values:

Address	Binary Value	Decimal Equivalent
O:e.0	0000 0000 0010 1001	41
O:e.1	0000 0000 0010 1001	41
O:e.2	0000 0000 0010 1001	41
O:e.3	0000 0000 0010 1001	41

e = slot number

2. Let the operating temperature stabilize for **2** minutes.
3. Use the precision input source to provide a 15 mA input across a channel's input terminals.

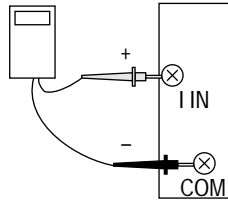

4. Verify that the input data is between **15110** and **15260** counts.
5. Repeat steps 3 and 4 for each remaining channel.

Verifying Voltage Inputs (-INI4vi only)

1. Configure your module for ± 10 V input on all 4 channels using the following configuration word values:

Address	Binary Value	Decimal Equivalent
O:e.0	0000 0000 0010 0001	33
O:e.1	0000 0000 0010 0001	33
O:e.2	0000 0000 0010 0001	33
O:e.3	0000 0000 0010 0001	33

e = slot number

2. Let the operating temperature stabilize for **2** minutes.
3. Use the precision input source to provide a 10 Vdc input across a channel's input terminals.

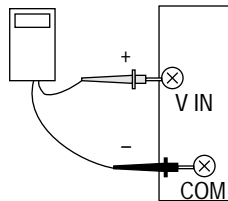

4. Verify that the input data is between **31805** and **32131** counts.
5. Repeat steps 3 and 4 for each remaining channel.

Service

If the input data is out of range, call the Spectrum Controls Customer Satisfaction department (206-746-9481) to make arrangements for returning your module for factory calibration.

Index

1746-NI4 compatibility, 30, 31

A

Abbreviations 4
Accuracy 6, 9
Addressing 19–21
Ambient temperature 13
Analog-to-digital conversion 4, 8
APS 27
Attenuation 4, 23
Autocalibration 7, 8, 25, 29, 32, 49

B

Backplane connector 12
Backplane current consumption 8, 12
Broken-wire response 7, 29, 32

C

c-UL 10
Cable, recommended 10, 14
Calibration 7, 8, 11, 49
CE 10
Certifications 10
Channel
 configuring 28
 enable/disable time 29
 error 37
 monitoring 35
 status 35
Chassis ground 15, 16–17
Common mode rejection 5, 8
Configuration words 5, 20, 28
Crosstalk 7
Current consumption 8, 12
Cut-off frequency 5

D

Data files 19
Data formats 9, 29, 30, 31
Data scaling 5
Data table 20
Data words 5, 20, 35
Diagnostic
 information 35, 45
 tests 7

Differential operation 5, 6, 16
DIP switches 20
Disable/enable time 29
Drift 6, 9

E

Effective resolution 5, 7, 22
Electrical noise 13, 14, 22
Electrostatic damage iii, 12
Empty slots 14
Enable/disable time 29
Enclosure 14
Engineering units 29, 30, 31
Error codes 45
Error flags 37
Error, full-scale 5
ESD iii

F

Fatal channel error 37
Features 7
Filter frequencies 5, 8, 9, 22, 25, 29, 32
Full-scale
 error 5
 range 6
 step response time 21

G

Gain drift 6
Gain error 5
Grounding 14, 15, 16

H

Hazardous locations 10
Hot-swapping 13
Humidity 10

I

I/O error codes 45
ID code 6, 8, 27
Image table 19
Impedance 9
Input image table 20
Input ranges 29, 30

Inspection 43
Installation 13–14
Isolation 7, 8

J

Jumper 11

L

Ladder programming 19
 examples 39
LEDs 7, 10, 45
Limits 20
LSB 6

M

Maintenance 47
Manuals, related 4
Memory map 20
Module ID code 6, 8, 27

N

Noise 7, 13, 14, 22
Non-fatal channel error 37
Normal mode rejection 6, 8

O

Open-circuit response 7, 29, 32
Operating ranges 9
Operating temperature 10
Opto-electrical isolation 8
Output image table 20
Over-current protection 7, 9
Over-range error 37
Over-voltage protection 7, 9

P

PID control 29, 30, 31, 39
Power requirements 8, 12
Powering up 44
Precision 9
Preventive maintenance 47
Programming 19–21
 equipment 27
 examples 39
Proportional counts 29, 30, 31

R

Rack 6
 choosing slot 13
 inserting module 13–14
 power requirements 12

Range error 37
Range, full-scale 6
Relative humidity 10
Removable terminal block 10
Repackaging iii, 12
Repeatability 6
Resolution 5, 6, 7, 9, 22
Response time 21

S

Safety 47
Sampling time 6
Scale limits 20
Scaled for PID 29, 30, 31
Scaling 5, 29, 30, 31, 33, 41
Schematics 18
Service 50
Shipping iii, 12
Signal attenuation 4, 23
Single-ended operation 18
Slot
 disabling 26
 inserting module into 13–14
 selecting 13
Specifications 8
Static shielded container 12
Status 6
Status bits 7, 20, 35
Step response time 6, 9, 21
Storage temperature 10

T

Terminal block 10
 removing 13
Terminal connections 17
Terms 4
Thermal dissipation 8
Troubleshooting 46

U

UL 10
Under-range error 37
Unused slots 14
Update time 4, 6, 9, 21
Useful resolution 6, 7, 22
User-defined scales 5, 20, 29, 30, 31, 33, 41

W

Waranty ii
Wire, routing 14
Wire, size 10
Wiring 14

Getting Technical Assistance

If you need technical assistance, please review the information in Chapter 6, “Testing Your Module,” before calling your local distributor of Spectrum Controls.

Note that your module contains electronic components which are susceptible to damage from electrostatic discharge (ESD). An electrostatic charge can accumulate on the surface of ordinary plastic wrapping or cushioning material. **In the unlikely event that the module should need to be returned to Spectrum Controls, please ensure that the unit is enclosed in approved ESD packaging (such as static-shielding / metallized bag or black conductive container).** Spectrum Controls reserves the right to void the warranty on any unit that is improperly packaged for shipment.

For further information or assistance, please contact your local distributor or call Spectrum Controls Customer Satisfaction department at (425) 746-9481 from 8:00 A.M. to 5:00 P.M. Pacific Time.

Declaration of Conformity

Available upon request.



The ENCOMPASS logo and SLC 500 are trademarks of Allen-Bradley Company, Inc. Copyright © 1998-2004, Spectrum Controls, Inc. All rights reserved. Printed in U.S.A. Specifications subject to change without notice. Publication 0300127-04 Rev. F March 2009

U.S.A. Headquarters
Spectrum Controls Inc.
P.O. Box 5533
Bellevue, Washington 98006
Fax: (425) 641-9473
Tel: (425) 746-9481

Web Site: <http://www.spectrumcontrols.com>
E-mail: spectrum@spectrumcontrols.com

